

FURNIKA

Mirror

2018/2019

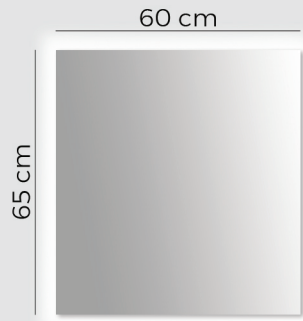

SP 1 / 60

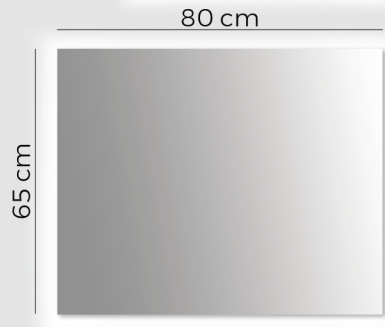

SP 1 / 80



SP 1 / 100

SP1 MIRROR

IP20 $\frac{kW}{l/000h}$ 9,7 

IN : 230V-50Hz;
OUT LED : 12VDC MAX 8,8 W

 6500K
1300 lm 

IP20 $\frac{kW}{l/000h}$ 11,0 

IN : 230V-50Hz;
OUT LED : 12VDC MAX 10,0 W

 6500K
1500 lm 

IP20 $\frac{kW}{l/000h}$ 12,1 

IN : 230V-50Hz;
OUT LED : 12VDC MAX 11,0 W

 6500K
1750 lm 

SAFE PACKAGING SYSTEM

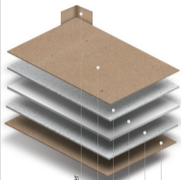

strengthening corner
cardboard
styrofoam
mirror
styrofoam
cardboard

TRANSPORT x15



PREPARATION FOR ASSEMBLY

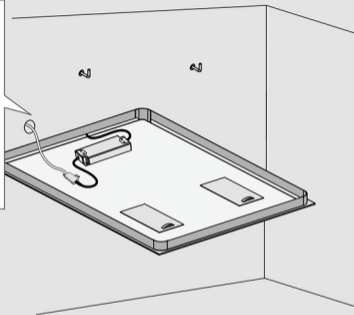
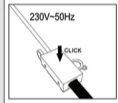

SIDE VIEW



TECHNICAL DATA

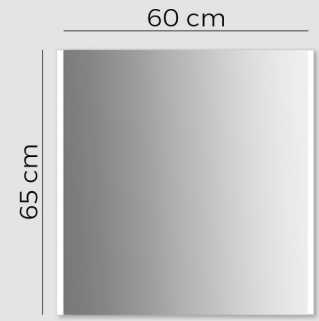

SP 2 / 60



SP 2 / 80



SP 2 / 100

SP2 MIRROR

IP20 $\frac{kW}{l \cdot 1000h}$ 12,7 CE

IN: 230V-50Hz;
OUT LED: 12VDC MAX 11,6 W

6500K
400 lm
A

IP20 $\frac{kW}{l \cdot 1000h}$ 12,7 CE

IN: 230V-50Hz;
OUT LED: 12VDC MAX 11,6 W

6500K
400 lm
A

IP20 $\frac{kW}{l \cdot 1000h}$ 12,7 CE

IN: 230V-50Hz;
OUT LED: 12VDC MAX 11,6 W

6500K
400 lm
A

SAFE PACKAGING SYSTEM

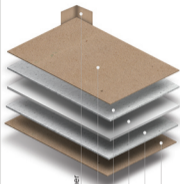

strengthening corner
cardboard
styrofoam
mirror
styrofoam
cardboard

TRANSPORT x8



PREPARATION FOR ASSEMBLY

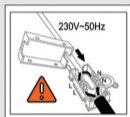
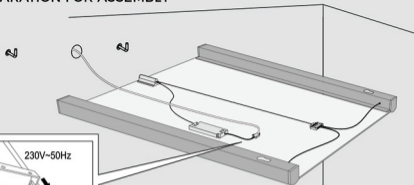

SIDE VIEW

MOVEMENT SWITCH

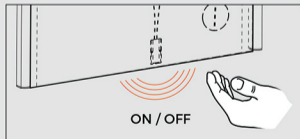

TECHNICAL DATA

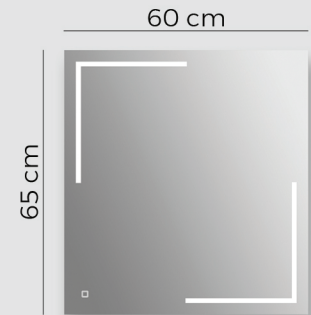

SP 3 / 60

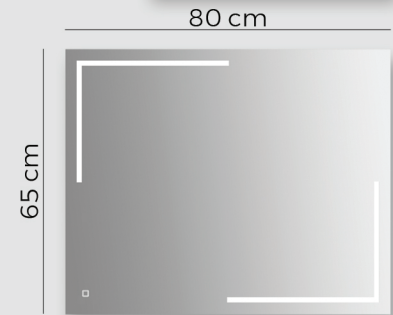

SP 3 / 80



SP 3 / 100

SP3 MIRROR

IP20 $\frac{\text{kWh}}{\text{l.000h}}$ 12,7

IN: 230V-50Hz;
OUT LED: 12VDC MAX 11,6W

6500K
250 lm

IP20 $\frac{\text{kWh}}{\text{l.000h}}$ 14,7

IN: 230V-50Hz;
OUT LED: 12VDC MAX 13,4W

6500K
290 lm

IP20 $\frac{\text{kWh}}{\text{l.000h}}$ 16,5

IN: 230V-50Hz;
OUT LED: 12VDC MAX 15,0W

6500K
330 lm

SAFE PACKAGING SYSTEM

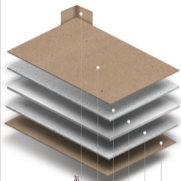

strengthening corner
cardboard
styrofoam
mirror
styrofoam
cardboard

TRANSPORT x8



PREPARATION FOR ASSEMBLY

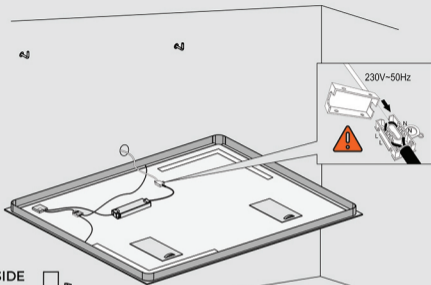

SIDE



TOUCH SWITCH

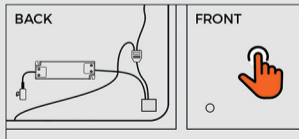

TECHNICAL DATA



MIRROR DEFOGGER



WATCH



MIRROR DEFOGGER



WATCH



MIRROR DEFOGGER



WATCH

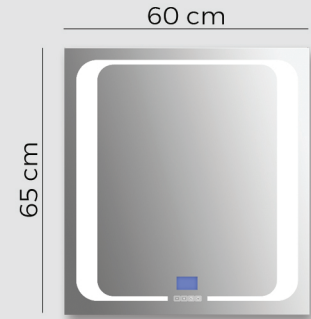

SP 4 / 60

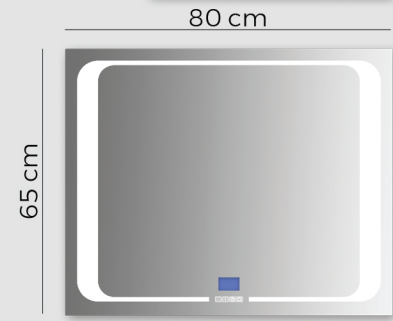

SP 4 / 80

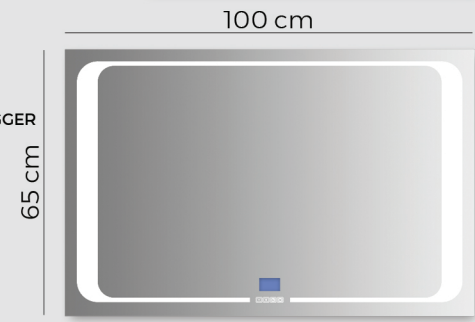

SP 4 / 100

SP4 MIRROR

IP20 kWh/1000h 30,2 CE

IN: 230V-50Hz; OUT LED : 12VDC MAX 11,6 W

6500K 400 lm A

IP20 kWh/1000h 33,0 CE

IN: 230V-50Hz; OUT LED : 12VDC MAX 30 W

6500K 535 lm A

IP20 kWh/1000h 33,0 CE

IN: 230V-50Hz; OUT LED : 12VDC MAX 30 W

6500K 595 lm A

SAFE PACKAGING SYSTEM

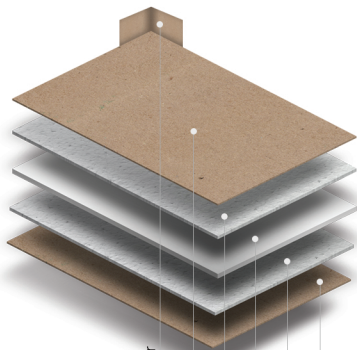

strengthening corner
cardboard
styrofoam
mirror
styrofoam
cardboard

TRANSPORT X8



PREPARATION FOR ASSEMBLY

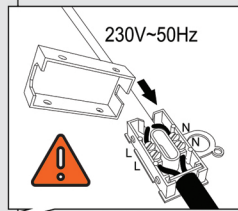
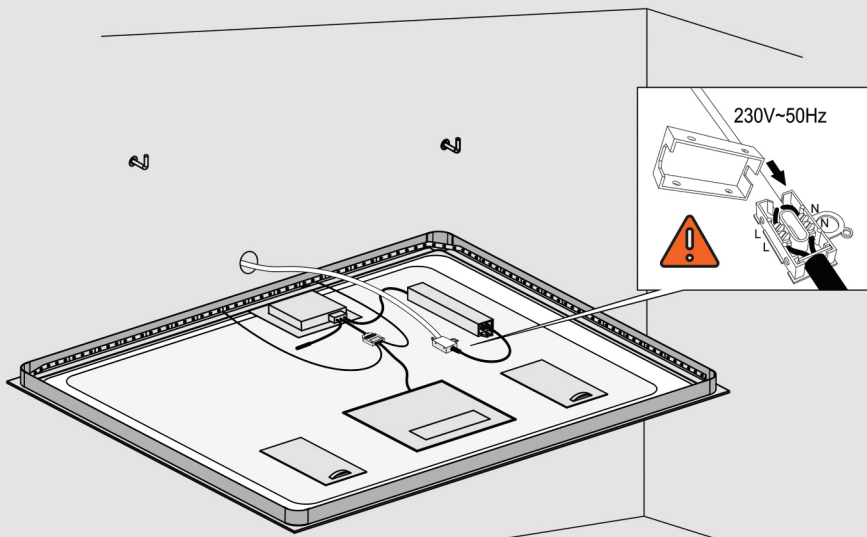

MIRROR WATCH & SWITCH

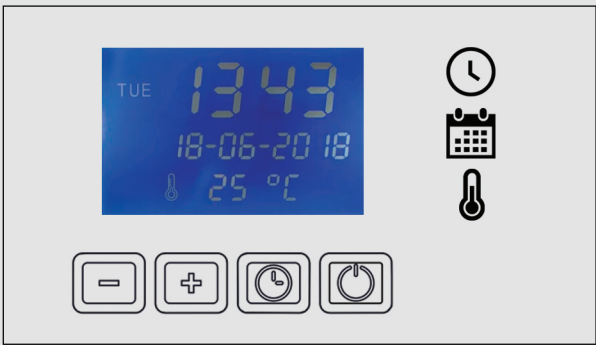

TECHNICAL DATA

Visit us

*www.***FURNIKA***.pl*
